

TECHNICAL PRECAUTIONS FOR DESIGN, INSTALLATION AND MAINTENANCE

WARNING

Read and follow all safety instructions!

These instructions contain important sections relative to safety, use, Maintenance, parts replacement and other technical information. Always include these instructions with the pulley.



CONTENTS

Installation & Maintenance

- | | |
|---|--|
| a) Transport and Handling | n) Surface Coating |
| b) Motorized Pulley Mounting Orientation | o) Belt Pull |
| c) Mounting Brackets | p) Mechanical Backstops |
| d) Electrical Installation | q) Electromagnetic Brake |
| e) Motor Current Overload and Over current Protection | r) Reversing Conveyors |
| f) Thermal Protection | s) Oil and Oil Seal Maintenance |
| g) Belt Tension | t) Re-greasable labyrinth seals |
| h) Belt Alignment | u) Pulley Diameter |
| i) Start-up | v) Terminal Box |
| j) Lagging | w) Variable frequency drive |
| k) Rubber lagging limitations | x) Capacitors |
| l) Actual Belt Speed vs. Nominal Belt Speed | y) Maintenance |
| m) Ambient Temperature | z) Aftermarket Service |
| | aa) Winding Diagrams |
| | bb) Storage of Motorized Pulleys |
| | cc) Dust explosion proof motorized pulleys (ATEX 95) |

CAUTION

Read the manual before installing or operating the pulley. Failure to understand how to install or operate the Pulley could cause personal injury or even death. Any modification made to or unintended use of the pulley could create a hazardous condition that could cause death or serious injury. Precautions which could effect warranty or create hazardous condition are marked with a safety symbol.



The drum motor must not be put into service until the machinery into which it is incorporated has been declared in conformity with the provision of the Directive 98/37/EEC & amendments. Also for testing the motor shafts have to be fixed to a frame properly before it is connected to the power supply and switched on. The shell has to be protected against accidental contact because of rotating.

IMPORTANT INFORMATION!

- After unpacking the pulley, inspect carefully for any damage that may have occurred during transit. Check to be sure all supplied accessories are enclosed with the unit. If you have questions regarding safety or damaged or missing parts, please call one of your nearest RULMECA representative listed at the back of the manual.
- It is the responsibility of the contactor, installer, owner and User to install, maintain and operate the conveyor, components and conveyor assemblies in such a manner as to comply with: The Williams-Steiger Occupational Safety and Health Act and with any and all state and local laws and ordinances as to the national and international standards as to: - ANSI – B20.1 Safety Code and Conveyor Equipment Manufacturers Association (CEMA) voluntary consensus standards which may prevail, - ANSI – Z535 Warning label Series - ISO 3864-2 Product Safety labels

When existing equipment is being retrofitted, upgraded or even changed, it is in customer's best interest to bring the equipment up to today's standards. If there are any questions, please contact RULMECA.

NOTICE

Refer to page 84 for explanation of the safety symbols used in this section of the catalogue.



Do not install standard motorized pulleys in areas with potentially explosive concentrations of vapors, gases, mists and dust.

TECHNICAL PRECAUTIONS FOR DESIGN, INSTALLATION AND MAINTENANCE

a) Transport/Handling:

- For safety reasons during transport and assembly a lifting rope according to the max. weight of the Pulley has to be used. The weight of the Pulley is stamped on the data plate and /or given in the catalogue.
- The rope has to be fixed on the shaft ends.
- As to Motorized Pulley types 500H – 1000HD, a steel rope or chains should be fixed to the eyebolts, which are located on the mounting brackets.

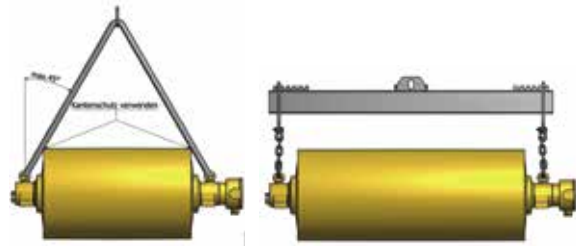

b) Motorized Pulley Mounting Orientation:

- Before installing the Motorized Pulley, please ensure that the data plate information is correct to your specification.
- At any time, Rulmeca Motorized Pulleys should always be mounted so that the Pulley shafts are
 1. Horizontal,
 2. Parallel to idler rollers, and
 3. Perpendicular to the conveyor belt **centreline**.
- As to Motorized Pulley types 138LS to 500M “UP” is indicated with the word “UP” stamped on the Pulley shaft.
- All Motorized Pulleys are to be mounted as shown on the sketch below.

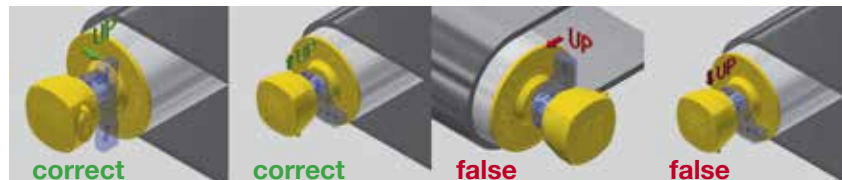
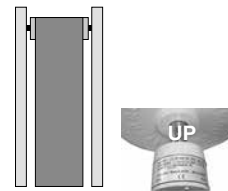

- **This instruction does not apply to types 500H - 1000HD.**
- **In case of a non-horizontal installation, of more than +/-5 degree, please consult Rulmeca.**
- **For Motorized Pulley types 500H - 1000HD please ensure that:** Motorized Pulley's are positioned in such a way that the mounting brackets are located horizontal or vertical to the conveyor frame. The cable entry of the terminal box should be located downwards or in a 90° position.



- At any time all Rulmeca Motorized Pulleys shown in this catalogue must be fitted with a conveyor belt to prevent overheating.
- **Motorized Pulleys fitted without a belt must be referred to Rulmeca.**
- **Installation and mounting of the Motorized Pulley in another position as described could cause severe product damage and voids product warranty.**

NOTICE

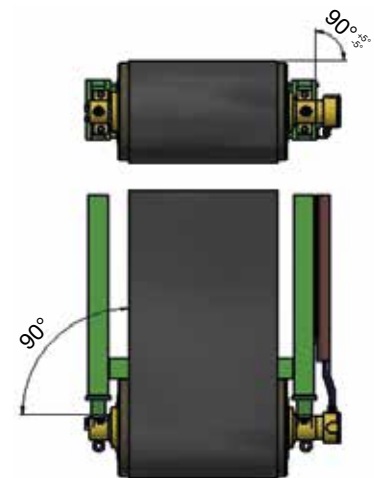

NOTICE

c) Mounting Bracket:

- As listed in the catalogue, use the **correct Rulmeca** mounting brackets matching the respective types of Motorized Pulleys.
- Note that it is physically possible, but not permissible, to interchange mounting brackets between models. Mounting brackets designed for smaller diameters or lower-powered Pulleys may not be used for larger diameters or higher-powered Pulleys.**
- Mounting brackets must be mounted to frame in such a way that belt pull is resisted by the shoulder or base of the mounting bracket. Motorized Pulleys types 138 LS to 400H have a top shaft retaining plate. This plate is not designed to resist belt pull.

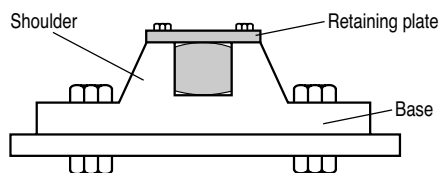

- The designer must select appropriate mounting bolts to resist belt forces and/or the weight of the Pulley depending on the mounting position of the Pulley.
- All types of mounting brackets must be fully supported by and fastened to the conveyor frame in such a way that the shafts ends do not deform. Shaft ends must always be fully supported by the brackets.
- Where solid mounting brackets type AL and ALO are used, the brackets have to be assembled close to the shoulder of the round shaft. This is to ensure that the drum motor has no axial clearance.
- The AL type of bracket is fitted with one or two keys depending on load.
- Keys must be securely fixed and checked regularly and locked if necessary.
- Mounting brackets should be fitted in such a way that they are in contact with the shoulder of each shaft. This will:
 - Eliminate Motorized Pulley axial play between mounting brackets.
 - Keep shaft deflection to a minimum.

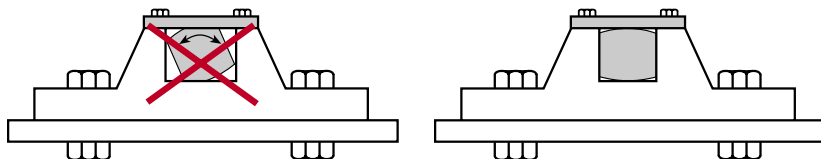

- Only the use of Rulmeca mounting brackets guarantees the perfect function of the drum motor and the achievement of the technical values according to the catalog. Other fixings can lead to a restricted function, up to and including loss of guarantee.
- In noise-sensitive areas, the designer should use heavier gauge support structure and appropriate vibration isolating material, as necessary.
- When Rulmeca Motorized Pulley mounting brackets are NOT used, it is essential that:**
 - The mounting equipment supports at least 80% of the shaft flats.
 - It has to be assembled without any clearance between the support and the shoulder of the shaft.
 - The clearance between the shaft flats shoulder and the support should be less than 0.4 mm (torsion play).
- A Motorized Pulley with frequent reversible operations or many start/stops should be mounted with **NO axial clearance** between the shaft flat shoulder and the brackets
- Failing to follow these precautions could cause Pulley and/or mounting bracket damage and *voids product warranty*.

NOTICE

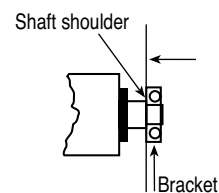

NOTICE

NOTICE

TECHNICAL PRECAUTIONS FOR DESIGN, INSTALLATION AND MAINTENANCE

d) Electrical Installation:

- Always use licensed electrician to install the unit. All electrical installation and wiring shall Conform to the national code of the National Electrical Standards. Turn the electrical power off at the electrical panel board (circuit breaker or fuse box) and lock or tag the panel board door to prevent someone from turning on power while you are working on the unit, failure to do so could result in serious electrical shock, burns or possible death. According to the European Council Directives related to machinery, the equipment manufacturer (OEM) has to secure that the Motorized Pulley is NOT put into operation before it is
 - Correctly installed,
 - Correctly connected to the power supply,
 - Correctly protected against rotating parts.
- A specialist must perform the electrical connection of the Motorized Pulley in accordance with electrical regulations. If in doubt, contact Rulmeca.
- A wiring diagram is always supplied with the Motorized Pulley. Always refer to the connection instructions and ensure that the motor power and control circuits are properly connected.
- The wiring diagram is inserted in the accompanying booklet and into the terminal box.
- As standard, Rulmeca Motorized Pulleys are delivered with clockwise rotation when viewed from the terminal box end of the Motorized Pulley.
- Always refer to the connection instructions and ensure that the motor is connected as required to the correct mains supply.
- As a safety measure, please use the earth screw located in the terminal box.
- The protective conductor has to be connected to the earth screw.
- When using cable options the green/ yellow wire has to be connected to the protective conductor of the main supply.

All safety devices, including wiring of electrical safety devices itself will not result in a hazardous condition.

e) Motor Current Overload and Over current Protection:

- Motor control systems must include protection against operating Pulley motors in excess of Full Load Amperage (FLA.). The control system should also include protection against voltage spikes and excessive joggling of motors. Failing to provide adequate current overload and over current protection could stress the motor and **voids product warranty**.
- FLA data is available for all motors upon request. FLA data is also supplied on motor label for each Motorized Pulley.
- Electrical power, control, and protection for Motorized Pulleys must adhere to all pertinent regulations.

f) Motor Thermal Protection:

- **All Motorized Pulley motors are supplied with a built-in thermal protector in each phase.** Protection consists of heat-sensitive, bi-metallic switches built into each motor phase winding. The switches are designed to open if motor temperature elevates to an inappropriately high level. 2.5 Amps are the permissible current of standard versions. The voltage is 230V.
- These switches must be connected to a normally closed control circuit (in series with a magnetic coil/relay device and contactor) in order **to validate product warranty**.
- A motor control circuit should kill motor power if thermal switch opens. Thermal switches will automatically close as motor cools. Cooling times vary with Pulley model, power, and size. However, 30 to 60 minutes is common with most motors in an ambient temperature of 20°C.

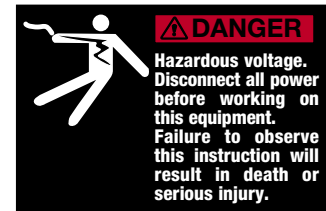

Earth connection

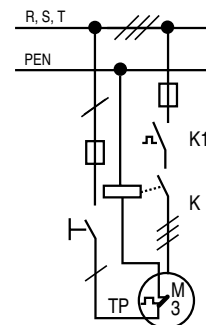

g) Belt Tension:

- The conveyor belt should never be over-tensioned. It should be installed with **sufficient belt tension only** to prevent belt slippage.
Refer to the motorized pulley range for the list of belt tension!
- To keep the radial load as low as possible to drive the belt without slipping anti-slip lagging should be used.
- Maximum allowable radial load of each Motorized Pulley (MP) is specified in this catalogue. Subjecting the Motorized Pulley to a higher than specified maximum radial load may damage internal components and shorten product lifetime and, therefore, **voids product warranty**.
- To check Pulley radial load, do a vector summation of the loads on the Pulley.
- For example, as shown in the diagram,
 1. Radial load equals $T_1 + T_2$.
 2. T_1 , tight side tension, equals Belt Pull (F_u) plus T_2 .
 3. T_2 , slack side tension, is determined using CEMA standard calculations or DIN 22101 to provide enough friction between the Pulley and the belt to drive the belt.
 Belt type, belt thickness and the right diameter of the Pulley have to be selected according to Belt Supplier Requirements.

h) Belt Alignment:

- Motorized Pulleys must be installed with Pulley shaft perpendicular to belt centreline and parallel to all idler rollers.
- Belt centreline must be straight and parallel to side walls of slider bed (if any) and perpendicular to idler rollers and all Pulleys
- Belt and/or roller misalignment may cause high friction and overload the conveyor belt drive motor.
- Belt misalignment may cause premature wear of Pulley lagging.

i) Start-up:

- **Prior to initial start-up of Motorized Pulley:**
 - Verify that Motorized Pulley nameplate data matches customer specification.
 - Ensure electrical connections are correct.
 - Check that Motorized Pulley is free to rotate.
 - Check that slack side belt tension is adequate to prevent belt slippage.
 - Check that belt is not over-tensioned.
 - Ensure the oil is present in the Motorized Pulley.

Lagging options:

- Smooth and diamond pattern lagging is available in black synthetic rubber and white synthetic rubber.
Approximate rubber hardness is 65 durometer (shore hardness A).
- Standard lagging is cold-bonded to Pulley shell.
- Optional hot vulcanised lagging is available for high power/high torque/high temperature applications and for Motorized Pulleys with Class H motors.
- Oil & grease resistant synthetic rubber is also available for oily operating conditions and/or for certain types of belting material. Check with belting supplier if belt/lagging material compatibility could be a problem.
- Adequate Motorized Pulley heat dissipation is necessary.
Lagging thickness and width greatly affect Pulley heat dissipation characteristics!

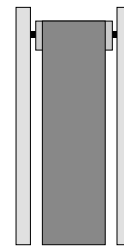
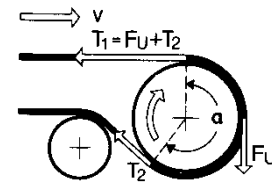
NOTICE

TECHNICAL PRECAUTIONS FOR DESIGN, INSTALLATION AND MAINTENANCE

Lagging Limitations: Lagging limitation (brief overview - for detailed proposal please ask your Rulmeca partner):

Motorized Pulley type /power	RL (mm)	Cold bonded 3mm	Cold bonded 5mm	Cold bonded 6mm	Hot vulc. 6mm	Cold bonded 8mm	Hot vulc. 8mm	Cold vulc. 10mm	Hot vulc. 10mm	Partial hot vulc. 10mm	Partial cold vulc. 10mm	Ceramic 10mm, moulded or direct glued	Ceramic/ rubber 10mm
138LS up to 0.37kW 0.55 & 0.75 & 1.0kW 0.55 & 0.75 & 1.0kW 0.55 & 0.75 (>= 0.63m/s)	up to 599 from 600 from 600	x x x x	x x x x	x - x x	x - x x	x - - x	x - - x	- - - x	- - - x	- - - -	- - - -	- - - -	- - - -
165LS up to 0.75kW 1.1 & 1.5kW 1.1; 1.5 kW 1.1; 1.5 kW (>=1.25m/s)	up to 599 from 600 from 600	x x x x	x - x x	x x x x	x - x x	x - - x	x - x x	x - - x	x - - x	- - - -	- - - -	- - - -	- - - -
220M & 220H up to 1.5kW 2.2 & 3.0kW dito 4.0kW dito 5.5kW dito	from 400 up to 799 from 800 up to 699 from 700 up to 849 from 850	x x x x x x x	- - - - - x x	x x x - x - x	x x x x - - x	x - x - - - -	x - x - - - -	x - - - - - -	x - - - - - -	- - - - - - -	- - - - - - -	x x x x x x x	- - - - - - -
320M / 320H up to 5.5kW 7.5kW < RL1000 7.5kW > RL1000	- - -	x - -	x - x	x - x	x x x	x - -	x - -	- - -	- - -	- - -	- - -	x x x	x - -
400M & 400H up to 11.0kW 15.0kW (<= 1.6m/sec.) 15.0kW (>= 1.6m/sec.) 15.0kW (>=1.6m/sec.)	- - from 1150 from 1600	- - - -	- - - -	x - - -	x - - x	- - - x	x - - x	- - - -	- - - -	x x x x	- - x x	x x x x	x - Partial x
500H up to 18.5kW 22.0kW 30.0kW	- - from 1050	- - -	- - -	- x -	- - -	x - -	x x -	- - -	- - -	x x -	x x -	x x x	x Partial Partial
630M	-	-	-	-	-	x	x	-	x	x	x	x	x
630H 22.0kW 30.0kW (<1.6m/sec.) 30.0kW (>=1.6m/sec.) 37.0kW 45.0kW 45.0kW 55.0kW	- - - - up to 1299 from 1300 -	- - - - - - -	- - - - - - -	- - - - - - -	- - - - - - -	x - - - - x -	x - - - - x -	x - - - - - -	x x x x x x x	x x x x x x x	x x x x x x x	x x x x x x x	x x Partial Partial Partial x Partial
800M 45.0kW 55.0kW	- -	- -	- -	- -	- -	x -	x -	x -	x -	x x	x -	x x	x x
800 H/HD 55.0kW 55.0kW 75.0kW 75.0kW up to 132.0kW	up to 1299 from 1300 up to 1299 from 1300 -	- - - - -	- - - - -	- - - - -	- - - - -	- - - - -	- - - x -	- - - - -	- x - - -	x x x x x	- x - x -	x x x x x	Partial Partial Partial Partial Partial
1000 H/HD 160.0kW 200.0kW 250.0kW	- - -	- - -	- - -	- - -	- - -	- - -	- - -	- - -	- - -	- - -	- - -	x x x	- - -

*The data given here are indicative. For the exact final occupancy of the MP please contact RULMECA.

Available types of Motorized Pulley lagging



Rubber (cold bonded)

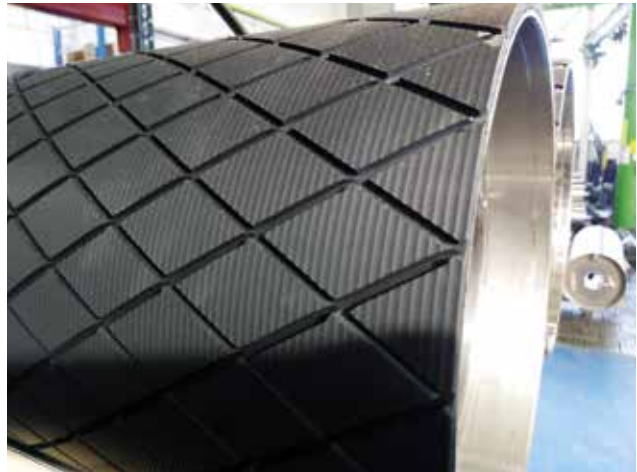

Rubber (hot vulcanized)



CK-X (ceramic tiles inside rubber)

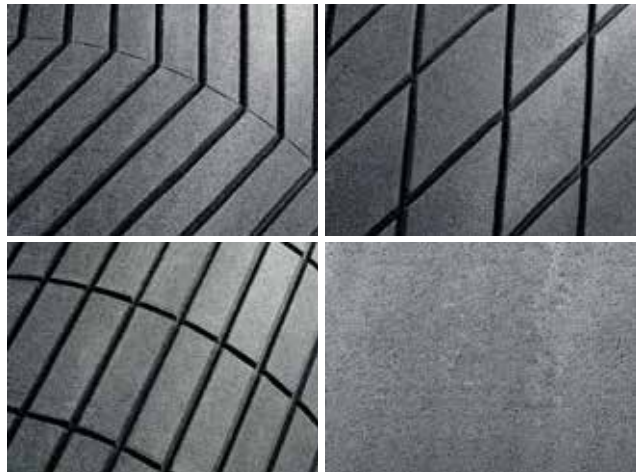

STS4000 (pure ceramic direct bonded to shell)

TECHNICAL PRECAUTIONS FOR DESIGN, INSTALLATION AND MAINTENANCE

I) Actual Belt Speed vs. Nominal Belt Speed:

- Two key specifications for each Motorized Pulley are Power (kW) and nominal belt speed (m/sec.), as given in the respective specifications in this catalogue.
- Nominal belt speed is a design target, providing consistent choices among all models and powers.
- Actual full load belt speed is almost never exactly equal to nominal belt speed.
- Actual belt speed is a function of the motor pole numbers, gear ratio and load. This catalogue displays the nominal belt speed at 50Hz.
- Note that **all** belt speeds shown in this catalogue refer to **un-lagged Pulleys** because:
 1. Belt speed for each model is a function of Pulley diameter,
 2. Pulleys are available with and without lagging,
 3. Lagging changes the Pulley diameter,
 4. Various lagging thickness are available.
- Note that each Rulmeca Motorized Pulley for a three-phase power supply uses an asynchronous squirrel cage induction motor with about 5% slip. In a no load condition, motor RPM is nearly equal to “synchronous speed” RPM. The slip rate is dependent on power and design of the motor. Low powered motors have a lower slip rate than high-powered motors.
- Pulley by Pulley the “nominal belt speed” displayed in this catalogue is based on un-lagged Pulleys running at full load, nominal voltage (e.g. 400V) and 50Hz.
- The nominal full load belt speed of a lagged Pulley running at
 1. Full load,
 2. Nominal voltage (e.g. 400 volts),
 3. 50 Hz– equals the nominal full load belt speed specified in this catalogue, times the ratio of the lagged/un-lagged Pulley diameters.

Example:

A 4.0kW Motorized Pulley 320M with an un-lagged Pulley diameter of 321mm has a nominal belt speed of 0.8 m/sec.

The actual belt speed is a function of

- The rotor speed (RPM),
- Gear ratio,
- Shell diameter and
- Load.

E.g. the above mentioned 320M with a nominal belt speed of 0.8m/sec. has

1. A gear ratio of $i = 28.6$,
2. A rotor speed of $n = 1440$ (1/min),
3. A shell diameter of 0.321 m.

The actual belt speed at full load is

$$v \text{ (m/sec)} = \pi \times d \text{ (m)} \times n \text{ (1/min)} / 60 \times i$$

$\pi = \text{Pie}$ (3.14),

$d = \text{Pulley diameter}$,

$n = \text{revolutions per minute}$,

$i = \text{gear ratio}$

$$v = (3.14 \times 0.321 \text{ m} \times 1440 \text{ 1/min}) / (60 \times 28.6) = 0.85 \text{ m/sec.}$$

If this Pulley is supplied with 10mm thick lagging, the belt speed of the lagged Pulley equals

$$0.85\text{m/sec.} \times (0.341\text{m}/0.321\text{m}) = 0.90\text{m/sec.}$$
 at full load, nominal voltage and 50Hz.

NOTICE

m) Ambient Temperature:

- Motorized Pulleys are normally cooled by dissipating heat through contact between the surface of the Pulley and the conveyor belt. It is essential that each Pulley have an adequate thermal gradient between the Pulley's motor stator and its ambient operating temperature.
- All Motorized Pulleys in this catalogue are designed and tested under full load without rubber lagging for a use in a max. ambient temperature of +40 °C. degree.
- Rubber lagging and/or higher ambient temperatures than +40 °C as well as conveying hot material will reduce the heat transfer from the electrical motor through the Pulley body to the air and/or the conveyor belt. This will always switch off the motor winding protection switch (motor thermal protection) and could possibly end-up in a burned motor winding.**
- Example:** A conveyor is running in a facility with an ambient temperature of 45 °C. The temperature of the motor cannot be dissipated as it should be. The motor temperature will increase to a dangerous level.
- Example:** A conveyor belt in an application with an ambient temperature of +24 °C, carrying processed material at a temperature of +70 °C, will have a Motorized Pulley "ambient temperature" that is significantly higher than +40 °C.
In this case, the temperature of the material is higher than the max. allowed ambient temperature which is necessary for a proper heat dissipation. A situation is then created due to **heat accumulation (heat storage) between the bottom of the belt and the Motorized Pulley body.**
- For ambient operating conditions lower or higher than allowable ambient temperature (-25 °C to 40 °C), contact Rulmecca.**
- In many cases it is possible to use specially designed Motorized Pulleys to perform tasks for special applications – e.g. modular plastic belts and v-belts for Motorized Pulley types 138LS & 165LS. Please contact Rulmecca for such applications.**
- Operating Rulmecca Motorized Pulleys to drive standard conveyor belts outside of the allowable ambient temperature range voids product warranty.**

n) Surface Coating:

- The Motorized Pulley types 400M to 1000HD are supplied with a salt water resistant primary paint coat of 60µm. For aggressive environmental conditions the Motorized Pulley should be painted to a thickness of 120µm.
- In this case it is essential to ensure that no paint material enters the gap between the shaft and the end housing to prevent possible damage to the shaft sealing.
Motorized Pulley types 220M to 320H are supplied with high resistant powder coated end housings. The shells and shafts are treated with anti-rust wax.

o) Belt Pull:

- The catalogue specifies "Actual Belt Pull" for each model, power, and speed of Pulley. Note that the specified actual belt pull allows for motor and gearbox efficiency losses (95 – 97%).
- Always select the Motorized Pulley power by comparing calculated "required belt pull (F)" with "Actual Belt Pull" and not simply on the basis of calculated Power (kW).
- Belt pull "F" is a summary of all of the existing forces to convey the material. E.g.
 - F1 - force to move the belt,
 - F2 - force to accelerate the material,
 - F3 - force to lift or lower the conveyed material,
 - F4 - force to clean the belt,
 - F5 - force to overcome the skirt board friction or roller resistance,
 - F6 - force to frictional resistance of ploughs, etc.

Furthermore, with special application additional power requirements can be needed (e.g. for belt operating under a hopper, squeezing of belt, belt guiding, extreme stiff belts etc.).

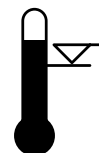

NOTICE

NOTICE

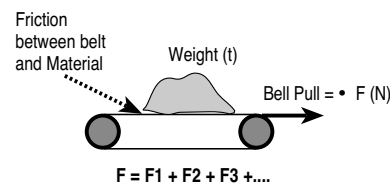

TECHNICAL PRECAUTIONS FOR DESIGN, INSTALLATION AND MAINTENANCE

p) Mechanical Backstops:

- **Motorized Pulleys fitted with mechanical backstops are used on inclined conveyors to prevent run back of the loaded belt when power supply is off.**
- The backstop is built into the Motorized Pulley and is mounted on the rotor shaft.
- If Pulley is supplied with optional mechanical backstop, direction of proper rotation of Pulley is indicated by an aluminium arrow or plastic sticker fastened to the end housing on the terminal box (or power cord) side of the Pulley. Clockwise or counter clockwise backstops are available.
- **Rotation direction is to be specified when placing the order.**
- Pulley rotation is specified from the point of view of a person looking at the Pulley from the terminal box (or power cord) side of the Pulley.
- It is essential that the identity of each of the three phases of the power supply be determined before attaching power supply wires to the Pulley to prevent motor from driving against the backstop. The identity of each of the three phases of the motor is clearly labelled on the terminal board, terminal strip, or wires (in power cord type).
- **Driving the motor against the mechanical backstop may damage motor and/or backstop and voids product warranty.**

q) Electromagnetic Brake:

- The spring-loaded electromagnetic brake is intended for use as a conveyor belt holding brake and a positioning brake.
- The control circuit for the Motorized Pulley motor and brake must be designed to stop the Pulley motor before brake clamps are shut and start the Pulley motor after the brake is released.
- Spring-loaded electromagnetic brakes are designed to release when power is applied to the brake coil. This is a “fail safe” feature. The clamp shuts when brake power is removed (either during normal operation or during an emergency loss of overall system power.)
- **Control circuits must be designed so that motor and brake NEVER work against each other. The brake should never be clamped shut when the motor is on except for “emergency stop” condition. The motor should never be powered on (including “jog” command) when the brake is clamped shut.**
- Electromagnetic brakes are DC-powered. They are supplied with AC to DC rectifiers to be mounted in a remote panel (by others). Rectifiers must be fuse-protected.
- Motor control circuits must be designed to kill motor power in the event of loss of brake power. If this safety provision is not made, it is possible for Pulley motor to be “powered through” a clamped brake, burning brake and/or motor.
- A wiring diagram is supplied with every Motorized Pulley. Always ensure that motor and brake power and control circuits are connected according to instructions.
- For rectifier connection and protection instructions, refer to rectifier data sheet supplied with Motorized Pulley.
- **Neglecting these instructions could cause damage to the motor and/or brake and voids product warranty.**

r) Reversing Conveyors:

- All Motorized Pulleys for a three-phase power supply are reversible. Mechanical backstop option is not possible for reversible conveyor applications.
- The conveyor drive control system must be designed to bring the Motorized Pulley to a complete stop before reversing conveyor belt direction.
- **Reversing conveyor direction without stopping the drive motor will damage motor and gearbox and voids product warranty.**

 **CAUTION**

NOTICE

NOTICE

NOTICE

s) Oil and Oil Seal Maintenance:

- Oil type and contents are given on the motor nameplate.
- Standard, synthetic, food grade, low viscosity (for low temperature applications,) and high viscosity (for noise-sensitive areas) are all available. For approved oil types and quantities, see pages 85.
- Motorized Pulleys require periodic oil changes and are supplied with two oil fill/drain plugs in end housing.
- Under normal operating condition the standard filling of the mineral oil should be changed after 20,000 operational hours. This is due to normal wear of gears.
- Synthetic oils should be changed after each 50,000 hours of normal operating condition.
- Magnetic oil plug(s) should be cleaned during each oil change. A red dot plastic sticker indicates the position of the magnetic oil plug.
- Only approved non-conductive oil may be used in Motorized Pulleys.
- Note that oil seals, regardless of oil type used, should be changed after 30,000 operating hours. On Motorized Pulley types 320M to 1000HD oil seals may be changed **without** removing Motorized Pulley from conveyor. Motorized Pulley standard types 220M to TM320L require Pulley disassembly to change oil seals. Rulmeca service personal or authorized local service providers to perform this work.

Take special precautions when changing brands of oil and types of oil because of potential oil incompatibility. Contact your local oil supplier for assistance.

- **For example**, when changing from standard to synthetic oil, it is necessary to:
 1. Completely drain old standard oil;
 2. Partially fill Pulley with “Clean-Flush-Lubricate” (CFL) fluid;
 3. Run Pulley for 20 minutes;
 4. Drain CFL fluid completely; then
 5. Fill Pulley with appropriate amount of new synthetic oil.
- Failing to observe these oil and oil seal precautions could shorten Pulley service life and voids product warranty.
- **All the above instructions refer to Motorized Pulleys CONSTANTLY working under FULL LOAD. In case of Motorized Pulleys NOT working continuously under full load, the service life will increase considerably! When checking the oil, the cleanness of the oil is always the best guideline of**
 - The wear and present position of the gears and bearings
 - Whether to change the oil immediately
 - Whether it is possible to delay the oil change.

t) Re-greasable labyrinth seals:

- All Rulmeca Motorized Pulleys are hermetically sealed. Standard oil seals are designed to contain oil within the Motorized Pulley during normal operating conditions. They are capable of withstanding an internal pressure rise that occurs as the Pulley motor temperature increases.
- Optional re-greasable labyrinth seals are available to protect oil seals from harsh operating or maintenance conditions. Each labyrinth seal provides a barrier of steel and grease to prevent ingress of dust and fluid through the oil seal.
- In abrasive operating conditions labyrinth seals should be periodically grease-purged to flush abrasive dust away from the oil seal.
- In wet and/or dirty conditions, where it is common to wash down equipment with high-pressure detergent spray, labyrinth seals should be refilled with grease after each wash-down. High-pressure sprays remove grease from the labyrinth seal, removing an important part of the barrier to fluid ingress.
- It has to be secured that grease is always seen at the labyrinth gap.
- If in some circumstances the re-grease frequency is too high a so-called “**Grease Man**” is recommended.
- Failing to perform necessary labyrinth seal maintenance could shorten service life and voids product warranty.

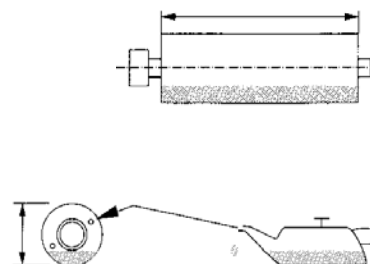

NOTICE

NOTICE

NOTICE

TECHNICAL PRECAUTIONS FOR DESIGN, INSTALLATION AND MAINTENANCE

u) Pulley Diameter:

- The type and size of conveyor belt will determine the minimum allowable Motorized Pulley diameter. Using a too small Pulley diameter, which does not match the belt, can cause belt de-lamination, belt splice damage and can shorten both belt and Pulley lagging life. Always contact your belting supplier before specifying a Pulley diameter.

v) Terminal Box:

- **Rulmeca** Motorized Pulleys are available with terminal boxes or power cords to facilitate electrical installation. Motorized Pulleys with power cords are available up to 4kW.
- Two main types of terminal boxes are used:
 1. A **compact terminal box** equipped with clamp terminals “WAGO” used for Motorized Pulley types up to 4.0 kW
 2. **Larger terminal boxes** with traditional threaded brass terminals.
- Switch off Motorized Pulley power supply and control circuit(s) before opening terminal box.
- Each terminal box has one or more conduit nipples and a cover plate. The cover plate should be removed to facilitate termination of power and control wires within the terminal box. After wire connections are made cover plate should be replaced.
- Terminal boxes should never be disassembled or removed from the end of the shaft to reorient conduit nipple location.
- Modifications to terminal boxes should only be made by an authorized **Rulmeca service centre** or after obtaining permission and instructions, in writing, from **Rulmeca**.
- A wiring diagram is placed inside the terminal box on the back of the terminal box cover. **Dismantling and reassembling terminal boxes could cause short circuits within the internal wiring, which is factory set (and tested) and would void product warranty.**



NOTICE

w) Variable frequency drive

- **Rulmeca drum motors are basically suitable for use with frequency converters.**
- The operator must ensure that the current national EMC guidelines are adhered to
- The motor cables must be shielded, and the max. Length must comply with the VFD manufacturer's specifications.
- With a nominal motor voltage > 600V, a du / dt filter must be used, this is dependent to select from the rated current.
- The allowable voltage peak for motors rated $\leq 690V$ is 980V.
- If frequency converters with pulse width modulation are used, ensure that no high-frequency transients occur with high voltage peaks.
- The following inverter data must be set and observed during operation:
 - Minimum clock frequency: 3kHz
 - Current limit: $1.2 * I_N$
 - Maximum overload time: 60s
 - Minimum frequency: 25Hz or 35Hz (at 60Hz base motor)
 - Maximum frequency: 55Hz or 65Hz (with 60Hz base motor)
- For Frequencies outside of this range please ask Rulmeca technical department for advise and confirmation first.
- The current monitoring of the frequency converter must match the rms value of the machine current with a record tolerance of $\pm 5\%$ relative to rated motor current.



NOTICE

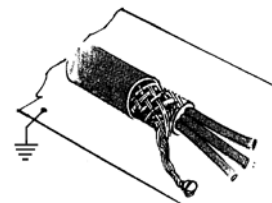

x) Capacitors (For Single Phase Motors):

- Each single phase Motorized Pulley requires an appropriate capacitor. For models 138LS and 165LS Start & RUN capacitors are supplied with the Pulley. Detailed information available on request. Using other than the specified RUN capacitors and a current dependent switching relays may damage the motor and voids product warranty.
- The RUN capacitors must be permanently connected to the motor, as shown on the connection diagrams.
- RULMECA single-phase motors are “permanent split phase motors”. Each motor is supplied with two windings. They are designed so that an appropriately sized capacitor connected to one of the windings will start the motor rotating.
- Starting torque is limited to 70% of full running torque if used without starting capacitor.
- It is possible to increase starting torque to 100% by adding a second appropriately sized capacitor (START capacitor) to the circuit. Note that this circuit must be designed to drop the starting capacitor out of the circuit after the motor has reached its nominal speed. Contact RULMECA for more information on how to run single-phase motors using START and RUN capacitors.

y) Maintenance:

- Normally Motorized Pulleys are maintenance free and require no specific attention during their operation. They are ready for operation immediately after connection to the power supply.
- **If repair or maintenance is required, the Motorized Pulley has to be disconnected from the supply before the terminal box can be opened. Turn the electrical power off at the electrical panel board (circuit breaker or fuse box) and lock or tag the panel board door to prevent someone from turning on power while you are working on the unit. Failure to do so could result in serious electrical shock, burn or possible death**
- During a test run, the shaft ends must be correctly fixed to the support frame, and suitable guarding must be provided around the rotating parts, for the protection of all personnel. **WARNING: DO NOT** operate without guards in place. Failure to follow these instructions could result in death or serious injury.

z) After Sales Service

- Always contact your local authorized Rulmeca service centre or distributor for aftermarket service or please refer to nearest Rulmeca distributor listed in our catalogue. Alternatively please refer to www.rulmeca.com.

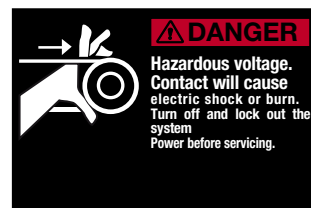

TECHNICAL PRECAUTIONS FOR DESIGN, INSTALLATION AND MAINTENANCE

aa) Wiring Diagrams

- Please refer to pages 87 ff.

NOTICE

bb) Storage of Motorized Pulleys

During storage RULMECA Motorized Pulleys

- should be stored in a house or as a minimum covered by an awning.
- have to be protected against direct influence of the sun to secure that the sealing system **does not dry out!**
- have to be turned 2 x 360° every year to make sure that all internal parts are being lubricated.

If Motorized Pulleys have stored longer than 1/2 year, they have to be tested before being put into operation. Such a test should include that

- The motor winding is checked with an insulation tester
- The winding resistance is checked
- The thermal protector is checked with continuity tester
- The Pulley is connected to the power supply and runs for a minimum of 30 minutes to check that there is NO oil leaks – make sure that the Pulley body temperature DOES NOT exceed 70°C degree.

For safety reasons make sure that the Pulley is proper fixed to the test frame during test.

cc) Dust explosion proof motorized pulleys (ATEX 95)

Since the use of electrical machinery in explosive dust areas is subject to strict legal regulations, we ask that you contact RULMECA and discuss the details of the operation before using Motorized Pulleys.

RULMECA will issue a case-related release for use.

Explanation of the symbols:

1. This is the alert symbol. It is used to alert you to potential bodily injury hazards. Obey all safety messages that follow this symbol to avoid possible injury or death.
2. These instructions and other product accompanying literature contain information that is important to know and understand. To help recognize the information, observe these symbols.



Danger indicates an imminently hazardous situation which, if not avoided, will result in death or serious injury.



Warning indicates a potentially hazardous situation which, if not avoided, could result in death or serious injury.



Caution indicates a potentially hazardous situation which, if not avoided, may result in minor or moderate injury.



Notice indicates important information, that if not followed, may cause damages to equipment.

