



### 2.6.1 - Impact rollers

Impact rollers are used and positioned corresponding to the load points, where the lumps and the weight of material falling onto the belt could in fact cause damage to it.

For the correct dimensioning and the choice of impact rollers in relation to the load check the characteristics of the base roller.

To limit the impact effect of the material onto the rollers, the latter are covered with a series of rubber rings of adequate thickness and resistance.

Impact rollers are under stress not only from the load of the material, but also from the dynamic forces as the load falls onto the belt.

The impact onto the belt, arising from the free fall of material (Fig.6) will be naturally greater than in the case where the material is deflected onto the belt by an inclined plate (Fig.7).

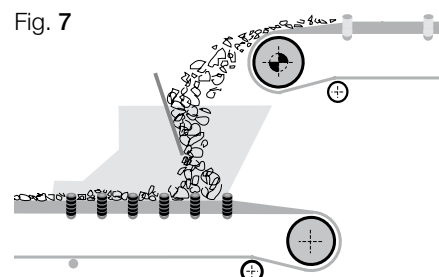
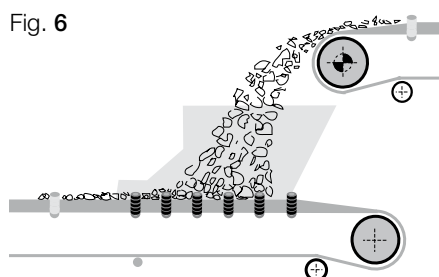

### Programme of production of impact rollers

basic roller type	D		Øe		spindle		bearing
	mm	s	mm	design	d	ch	
MPS 1	60	3	89	NA	15	17	6202
	60	3	108	NA			
PSV 1	63	3	89	NA	20	14	6204
	63	3	108	NA			
	89	3	133	NA			
	89	3	159	NA			
PSV 2	89	3	133	NA	25	18	6205
	89	3	159	NA			
PSV 3	89	3	133	NA	25	18	6305
	89	3	159	NA			
PSV 4	89	3	133	NA	30	22	6206
	89	3	159	NA			
PSV 5	89	4	133	NA	30	22	6306
	89	4	159	NA			
	108	4	180	NA			
	133	4	194	NA			
	133	4	215	NA			
PSV/7-FHD	108	4	180	NA	40	32	6308
	133	6	194	NA			
	133	6	215	NA			

The table indicates the types and diameters of standard rings and dimensions according to European norms. On request special diameters and tube thicknesses may be supplied.

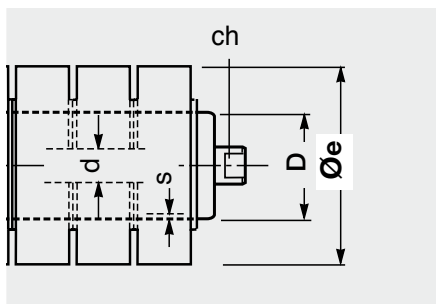



## 2 Rollers

series

**Impact**



### Øe 89 NA







Base roller:

#### MPS 1

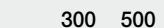
D = 60;  
spindle 15; d<sub>1</sub> = 20  
bearing 6202  
ch = 17

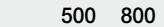
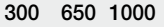
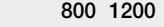
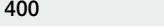
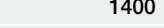
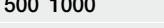
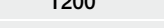
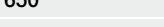
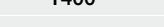
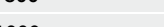
#### PSV 1

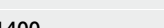
D = 63;  
spindle 20; d<sub>1</sub> = 20  
bearing 6204  
ch = 14

belt	roller						rings width
	width mm	dimensions mm			weight Kg		
arrangements	B	C	A	MPS 1	PSV 1	E = 35	
 400	160	168	186	1.8	2.3		
 300 500	200	208	226	2.1	2.7		
 400 650	250	258	276	2.6	3.3		
 500 800	315	323	341	3.3	4.1		
 300 650 1000	380	388	406	3.9	4.8		
 800 1200	465	473	491	4.6	5.6		
 400	500	508	526	5.1	6.1		
 1400	530	538	556		6.4		
 500 1000	600	608	626	6.1	7.2		
 1200	700	708	726	6.9	8.1		
 650	750	758	776	7.4	8.8		
 1400	800	808	826		9.2		
 800	950	958	976	9.3	10.9		
 1000	1150	1158	1176	11.1	12.9		
 1200	1400	1408	1426	13.5	15.7		
 1400	1600	1608	1626		17.9		

Example of ordering  
standard design  
MPS1,15B,89NA,323

for special designs  
see pages 80-81

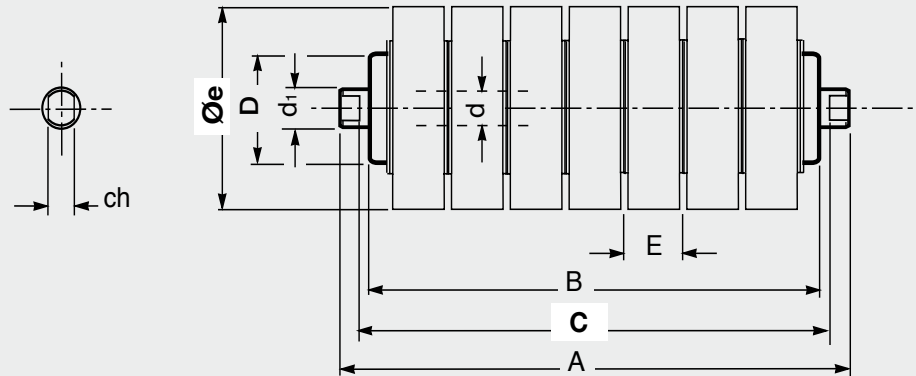

## Øe 108 NA

Base roller:

### MPS 1

D = 60;  
spindle 15; d<sub>1</sub> = 20  
bearing 6202  
ch = 17

### PSV 1

D = 63;  
spindle 20; d<sub>1</sub> = 20  
bearing 6204  
ch = 14

belt	roller						
	width mm	dimensions mm			weight Kg		rings width
arrangements		B	C	A	MPS 1	PSV 1	E = 45
	400	160	168	186	2.1	2.6	
	300 500	200	208	226	2.6	3.2	
	400 650	250	258	276	3.1	3.8	
	500 800	315	323	341	4.0	4.8	
	300 650 1000	380	388	406	4.6	5.5	
	800 1200	465	473	491	5.7	6.6	
	400	500	508	526	6.1	7.1	
	1400	530	538	556		7.3	
	500 1000	600	608	626	7.5	8.6	
	1200	700	708	726	8.6	9.9	
	650	750	758	776	9.2	10.5	
	1400	800	808	826		11.1	
	800	950	958	976	11.6	13.2	
	1000	1150	1158	1176	13.8	15.7	
	1200	1400	1408	1426	16.6	18.8	
	1400	1600	1608	1626		21.5	

**Example of ordering**  
standard design  
PSV1,20F,108NA,323

for special designs  
see pages 80-81



## 2 Rollers

### series Impact

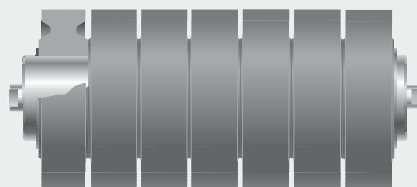

## Øe 133 NA

Base roller:

#### PSV 1

D = 89;  
spindle 20; d<sub>1</sub> = 20  
bearing 6204  
ch = 14

#### PSV 4

D = 89;  
spindle 30; d<sub>1</sub> = 30  
bearing 6206  
ch = 22

#### PSV 2

D = 89;  
spindle 25; d<sub>1</sub> = 25  
bearing 6205  
ch = 18

#### PSV 5

D = 89 x 4\*;  
spindle 30; d<sub>1</sub> = 30  
bearing 6306  
ch = 22

#### PSV 3

D = 89;  
spindle 25; d<sub>1</sub> = 25  
bearing 6305  
ch = 18

\* bigger tube thickness than standard

Example of ordering  
standard design  
PSV2,25F,133NA,388

for special designs  
see pages 80-81

belt width mm	roller dimensions mm					weight Kg					rings width
	arrangements					PSV 1	PSV 2	PSV 3	PSV 4	PSV 5	
	B	C	A								
	500	200	208	*	3.7						
	650	250	258	*	4.5	5.1					
	500 800	315	323	*	5.6	6.2	6.5	7.3	7.9		
	650 1000	380	388	*	6.6	7.3	7.7	8.5	9.1		
	800 1200	465	473	*	7.8	8.6	8.9	9.9	10.5		
	1400	530	538	*	8.8	9.7	10.1	11.2	11.8		
	500 1000 1600	600	608	*	10.1	11.1	11.4	12.7	13.3		
	1800	670	678	*		12.2	12.6	13.9	14.5		
	1200	700	708	*	11.4	12.6	12.9	14.3	14.9		
	650 2000	750	758	*	12.3	13.5	13.9	15.3	15.9		
	1400	800	808	*	12.9	14.2	14.6	16.2	16.4		
	1600	900	908	*	14.5	15.9	16.3	18.0	18.6		
	800	950	958	*	14.6	17.1	17.5	19.3	19.9		
	1800	1000	1008	*		18.2	18.4	20.1	20.7		
	2000	1100	1108	*			19.8	21.7	22.3		
	1000	1150	1158	*	18.7	20.5	20.8	23.0	23.6		
	1200	1400	1408	*	22.4	24.6	24.9	27.5	28.1		
	1400	1600	1608	*	25.5	27.9	28.3	31.2	31.8		
	1600	1800	1808	*	28.0	30.7	31.0	34.3	34.9		
	1800	2000	2008	*		34.0	34.4	38.0	38.6		
	2000	2200	2208	*			37.5	41.5	42.1		

\* in relation to the choice of base roller

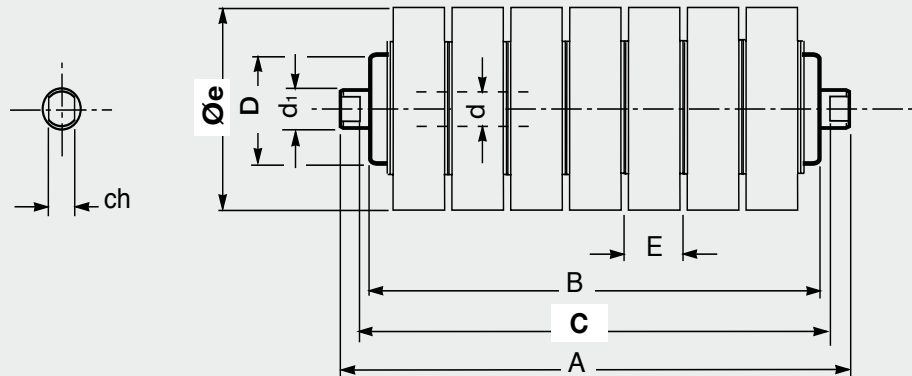

## Øe 159 NA

Base roller:

### PSV 1

D = 89;  
spindle 20; d<sub>1</sub> = 20  
bearing 6204  
ch = 14

### PSV 4

D = 89;  
spindle 30; d<sub>1</sub> = 30  
bearing 6206  
ch = 22

### PSV 2

D = 89;  
spindle 25; d<sub>1</sub> = 25  
bearing 6205  
ch = 18

### PSV 5

D = 89 x 4\*;  
spindle 30; d<sub>1</sub> = 30  
bearing 6306  
ch = 22

### PSV 3

D = 89;  
spindle 25; d<sub>1</sub> = 25  
bearing 6305  
ch = 18

\* bigger tube thickness than standard

belt	roller					rings width		
	width mm	dimensions mm			weight Kg			
arrangements	arrangements					E = 50		
	B	C	A	PSV 1	PSV 2		PSV 3	PSV 4
800	315	<b>323</b>	*	7.3	7.9	8.2	9.0	9.0
1000	380	<b>388</b>	*	8.4	9.2	9.5	10.4	11.0
800 1200	465	<b>473</b>	*	10.4	11.3	11.6	12.6	12.2
1400	530	<b>538</b>	*	11.6	12.5	12.9	14.0	14.6
1000 1600	600	<b>608</b>	*	13.4	14.5	14.8	16.1	16.7
1800	670	<b>678</b>	*	15.8	16.2	17.5	18.1	
1200	700	<b>708</b>	*	15.5	16.7	17.1	18.5	19.1
2000	750	<b>758</b>	*	16.6	17.8	18.2	19.7	20.3
1400	800	<b>808</b>	*	17.7	19.0	19.3	20.9	21.5
1600	900	<b>908</b>	*	19.8	21.2	21.6	23.3	23.9
800	950	<b>958</b>	*	20.6	22.3	22.7	24.5	25.1
1800	1000	<b>1008</b>	*	23.4	23.8	25.7	26.3	
2000	1100	<b>1108</b>	*	26.0	28.1	28.7		
1000	1150	<b>1158</b>	*	25.0	26.8	27.2	29.3	29.9
1200	1400	<b>1408</b>	*	30.3	32.4	32.8	35.4	36.0
1400	1600	<b>1608</b>	*	35.1	37.5	37.9	40.8	41.4
1600	1800	<b>1808</b>	*	39.3	42.0	42.4	45.6	46.2
1800	2000	<b>2008</b>	*	46.5	46.9	50.5	51.1	
2000	2200	<b>2208</b>	*	51.3	55.3	59.9		

\* in relation to the choice of base roller

Example of ordering  
standard design  
PSV4,30F,159NA,473

for special designs  
see pages 80-81



## 2 Rollers

### series Impact



## Øe 180 NA

Base roller:

### PSV 5

D = 108 x 4\*;  
spindle 30; d<sub>1</sub> = 30  
bearing 6306  
ch = 22

### PSV/7-FHD

D = 108 x 4\*;  
spindle 40; d<sub>1</sub> = 40  
bearing 6308  
ch = 32

\* bigger tube thickness than standard

Example of ordering  
standard design  
PSV5,30F,180NA,678

for special designs  
see pages 80-81

belt width mm	roller dimensions mm				weight Kg		rings width
	B	C	A		PSV 5	PSV/7-FHD	
arrangements 							E = 40
1600	600	608	632		20.1	25.3	
1800	670	678	702		22.5	28.1	
2000	750	758	782		24.9	30.8	
2200	800	808	832		26.9	33.0	
1600 2400	900	908	932		29.7	36.2	
2600	950	958	982		31.7	38.4	
1800	1000	1008	1032		33.1	40.0	
2800	1050	1058	1082		34.4	41.6	
2000	1100	1108	1132		36.4	43.6	
3000	1120	1128	1152		36.7	44.2	
2200	1250	1258	1282		41.2	49.1	
2400	1400	1408	1432		45.9	54.5	
2600	1500	1508	1532		48.7	57.7	
2800	1600	1608	1632		52.1	61.4	
1600	1800	1808	1832		58.2	68.4	
1800	2000	2008	2032		64.9	76.0	
2000	2200	2208	2232		71.1	82.9	
2200	2500	2508	2532		80.6	93.6	
2400	2800	2808	2832		90.1	104.4	
2600	3000	3008	3032		96.2	111.3	
2800	3150	3158	3182		100.9	116.3	

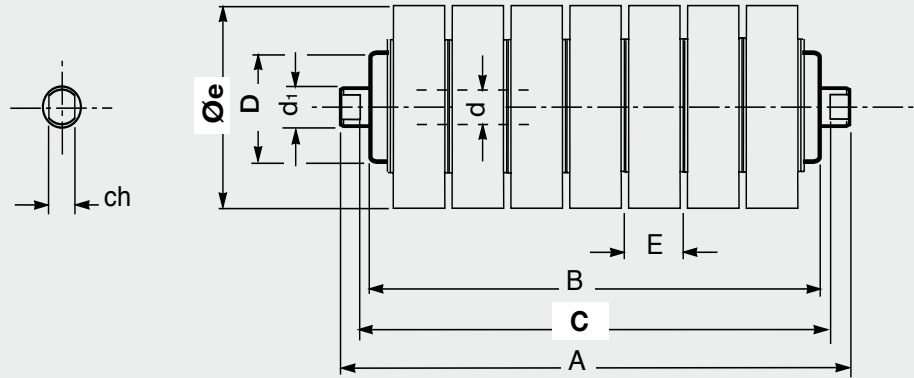

# Øe 194 NA

Base roller:

## PSV 5

D = 133;  
spindle 30; d<sub>1</sub> = 30  
bearing 6306  
ch = 22

## PSV/7-FHD

D = 133 x 6\*;  
spindle 40; d<sub>1</sub> = 4  
bearing 6308  
ch = 32

\* bigger tube thickness than standard

belt	roller						
	width mm	dimensions mm			weight Kg		rings width
arrangements	B	C	A	PSV 5	PSV/7-FHD	E = 50	
	1600	600	608	632	23.4	28.1	
	1800	670	678	702	25.5	30.5	
	2000	750	758	782	28.6	34.0	
	2200	800	808	832	30.3	35.9	
	1600 2400	900	908	932	33.8	39.8	
	2600	950	958	982	35.5	41.8	
	1800	1000	1008	1032	37.2	43.7	
	2800	1050	1058	1082	39.0	45.7	
	2000	1100	1108	1132	40.7	47.6	
	3000	1120	1128	1152	41.1	48.1	
	2200	1250	1258	1282	45.9	53.5	
	2400	1400	1408	1432	51.1	59.3	
	2600	1500	1508	1532	54.6	63.2	
	2800	1600	1608	1632	58.1	66.9	
	1600	1800	1808	1832	65.0	74.9	
	1800	2000	2008	2032	71.9	82.7	
	2000	2200	2208	2232	78.9	90.5	
	2200	2500	2508	2532	89.3	102.2	
	2400	2800	2808	2832	99.7	113.9	
	2600	3000	3008	3032	106.6	121.7	
	2800	3150	3158	3182	111.8	127.5	

Example of ordering  
standard design  
PSV5,30F,194NA,678

for special designs  
see pages 80-81



## 2 Rollers

### series Impact

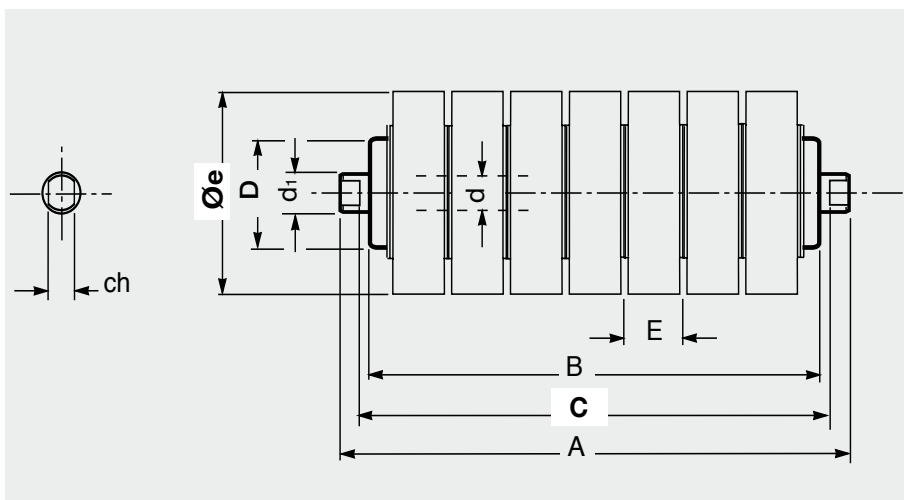

## Øe 215 NA

Base roller:

### PSV 5

D = 133;  
spindle 30; d<sub>1</sub> = 30  
bearing 6306  
ch = 22

### PSV/7-FHD

D = 133x 6\*;  
spindle 40; d<sub>1</sub> = 40  
bearing 6308  
ch = 32

\* bigger tube thickness than standard

belt	roller						
	width mm	dimensions mm			weight Kg		rings width
arrangements	B	C	A	PSV 5	PSV/7-FHD	E = 50	
	1800	670	678	702	27.6	32.6	
	2000	750	758	782	31.0	36.4	
	2200	800	808	832	32.9	38.5	
	2400	900	908	932	36.7	42.7	
	2600	950	958	982	38.6	44.8	
	1800	1000	1008	1032	40.4	46.9	
	2800	1050	1058	1082	42.3	49.0	
	2000	1100	1108	1132	44.2	51.1	
	3000	1120	1128	1152	44.6	51.6	
	2200	1250	1258	1282	49.9	57.5	
	2400	1400	1408	1432	55.6	63.8	
	2600	1500	1508	1532	59.4	68.0	
	2800	1600	1608	1632	63.2	72.2	
	1800	2000	2008	2032	78.3	89.1	
	2000	2200	2208	2232	85.9	97.5	
	2200	2500	2508	2532	97.3	110.2	
	2400	2800	2808	2832	108.6	122.8	
	2600	3000	3008	3032	116.2	131.3	
	2800	3150	3158	3182	121.9	137.6	

Example of ordering  
standard design  
PSV/7-FHD,40F,215NA,758

for special designs  
see pages 80-81

